



Experimentation for Microhardness and Residual  
Stress in Gaseous Assisted Powder Mixed Near  
Dry Electric Discharge Machining.

---

Sanjay Sundriyal, Vipin and Ravinder Singh Walia

EasyChair preprints are intended for rapid  
dissemination of research results and are  
integrated with the rest of EasyChair.

July 3, 2020

# Experimentation for Microhardness and Residual Stress in Gaseous Assisted Powder Mixed Near Dry Electric Discharge Machining.

Sanjay Sundriyal<sup>1</sup>, Vipin<sup>2</sup> and R.S Walia<sup>3</sup>

<sup>1,2</sup> Delhi Technological University, Delhi, India

<sup>3</sup> Punjab Engineering College, Punjab, India

Vipin@dce.ac.in

**Abstract.** Electric discharge machining (EDM) is a process to machine very hard conductive metals with intricate shapes which are very difficult to machine by any other conventional method. A recent trend in manufacturing industry has brought in Gaseous assisted powder mixed near dry EDM (GAPMND-EDM) methodology. This advanced version of EDM is not only much more efficient in terms of performance index but is also environmental friendly. In this study, an approach has been made for experimental comparison in GAPMND-EDM for different metallic powders (Al, Gr and Si) in terms of residual stress (RS) and microhardness (MH) of the machined EN-31 workpiece by using copper tool electrode. The RS decreased by 39.68% while the microhardness increased by 93.57% in GAPMND-EDM. Highest microhardness (MH) was 1235 Vickers hardness number (VHN) while lowest residual stress (RS) was 266 MPa.

**Keywords:** Microhardness, Residual stress, Metallic powder, Near Dry EDM, Gaseous.

## 1 Introduction

Electric discharge machining has been used extensively in manufacturing industry for various applications such as die processing, machining intricate shapes etc. The machined products by have some undesirable after effects in the mechanical properties of the samples due to phase transformation by heating, cooling and resolidification. These factors are responsible for induction of residual stresses in the machined workpieces. These residual stresses results in uncertainty of reliability of the product developed by EDM. Nowadays researchers have contributed immensely in different techniques in EDM so that these residual stresses can be minimized. Residual stress induced in the EDM'ed samples were minimized by optimization of process parameters by Taguchi methodology and it was stated that these stresses induced are very much dependent upon mechanical properties of the workpiece and the EDM process parameters [1]. Raman spectroscopy along with nano-indentation was adopted for study of residual stress in the machined products by EDM [2]. X-ray  $\cos \alpha$  principle was utilized for residual stress analysis in vibration assisted EDM. Continuous and discontinuous vibrations were supplied for enhanced performance characteristics. It was revealed by the study that discontinuous vibration resulted in reduced residual stresses induced in the machined sample [3]. Study for residual stress variation along the cross sectional depth of machined sample by EDM was performed and it was

stated that the induced stresses shows a increase trend in its value from the top of the machined surface. It reached the maximum value at some depth and then it starts decreasing to a minimum value [6]. Residual stress was measured by using deflection method for removing influential stressed layer over the machined surface by wire EDM [7]. Finite element analysis along with mathematical modelling was performed for analysis of residual stress generated in the workpiece by EDM and the study revealed that most critical residual stress exists at the near top surface due to higher machining temperature [8]. Residual stress for EDM'ed samples were studied by atomic force microscopy (AFM) and nano indentation techniques [9]. Study for peak value of residual stress was conducted and it was observed experimentally that the maximum value of these stresses are generated at depth of 40 $\mu$ m from the top surface of the workpiece and becomes negligible at depth of 200 $\mu$ m [10]. The maximum value for the generated residual stress by EDM in workpiece was near the ultimate strength of the work material [11]. Molecular dynamics simulation technique was used to study residual stress distribution over the machined surface by EDM [12].

Researchers have also contributed towards improving the morphology of the machined components by Powder additive EDM (PM-EDM) and capabilities of EDM was improved in terms of increased microhardness by powder additives [25]. Tungsten powder additives were introduced in the dielectric oil of EDM in order to modify the surface of the die steel workpiece. It was observed that powder additive in EDM enhances the surface microhardness property of the workpiece sample due to formation of carbides [4]. The micro hardness of cryogenically treated aluminium alloy was improved by 94.85% in PMDEM [5]. Titanium carbide powder was used to improve the surface properties of the workpieces machined by powder mixed- EDM. Metallic powder was suspended in the EDM oil to enhance the microhardness of the machined surface [14]. Cu and Mn powder metallurgical tool electrode was used to machined die steel (H11) and it was experimentally proved that the microhardness improved by 97.3% [15]. Cu-W (powder metallurgy) tool was used to machined EN-31 alloy steel in EDM and these developed tool electrodes increased the microhardness (~150%) by formation of carbides and cementites over the machined surface [16]. Electric discharge machining was performed on Ti6Al4V alloy by using powder metallurgy electrode of TiC/Cu. The microhardness was increased upto 912 HV (Vickers hardness) [17]. Novel optimization route in conjunction with Taguchi's philosophy was followed to improve Inconel 718 microhardness in EDM [18]. PM-EDM resulted in decrease of residual stress in the machined parts due to decrease in discharge energy density [19]. Morphology of machined Titanium alloy (Ti-6Al-4V) by EDM was studied and it was stated that pyrolysis effect of the dielectric medium resulted in carbon migration over the machined surface due to which the microhardness was increased to a higher value [20]. Vibration assisted EDM was introduced and it resulted that imparting discontinuous vibration at high frequency enhances the microhardness level of the machined sample [22]. Surface characteristics of Ti-6Al-4V were improved by SiC abrasive-mixed EDM with magnetic stirring. The microhardness of the specimen was improved drastically by SiC powder additives [27]. Metallic powder (Molybdenum) was used as an additive in EDM to im-

prove the microhardness of H13 steel specimen by formation of white layer (Fe-Mo and  $\text{Mo}_x\text{C}$ ) over the machined surface [28].

Inconel 718 was machined by PM-EDM and investigation led to conclusion that carbon enrichment over the machined surface leads to increased microhardness [30]. Subsurface of Ti-6Al-4V-ELI workpiece was improved in terms of microhardness in PM-EDM and it was revealed that unique mechanism of material transfer was responsible for formation of solid and harder sublayers over the machined surface [31].

## **2 Setup and Methodology**

Setup was developed ingeniously for GAPMND-EDM was developed to carry out the experiments as shown in Fig.1 while schematic diagram of the setup is shown in Fig.2. The setup comprises of gas pressure gauges, mixing chamber, dielectric flow meter and argon gas cylinder. Sparkonix EDM-35 (A) was used to supply power for experimentation for GAPMND-EDM. In EDM the erosion process takes place by the high thermal energy of intermittent sparks of high frequency at the machining gap between tool and workpiece electrodes. Although the working principle is same in GAPMND-EDM, but presence of inert gas (Ar) and metallic powders play a vital role in changing the machining performance and thereby changing the morphological properties of the machined product. The Inert gas supplied as shown in Fig.3, works as a protective atmosphere creating agent which reduces the oxidation and prevents the contaminants from entering the machining zone. This results in achievement of better surface properties such as reduced re-solidified layer over the parent material and less heat affected zone due to better cooling conditions. The metallic powder additives enhances the machining process by stabilizing the energized plasma generated at the machining gap. The experiments were performed by using different metallic powders (Gr, Al, Si) as dielectric additive at different experimental conditions as shown in Table 1 while Table 2 and Table 3 shows the physical and chemical properties of the workpiece respectively. The metallic powders chemical properties are shown in Table 4.

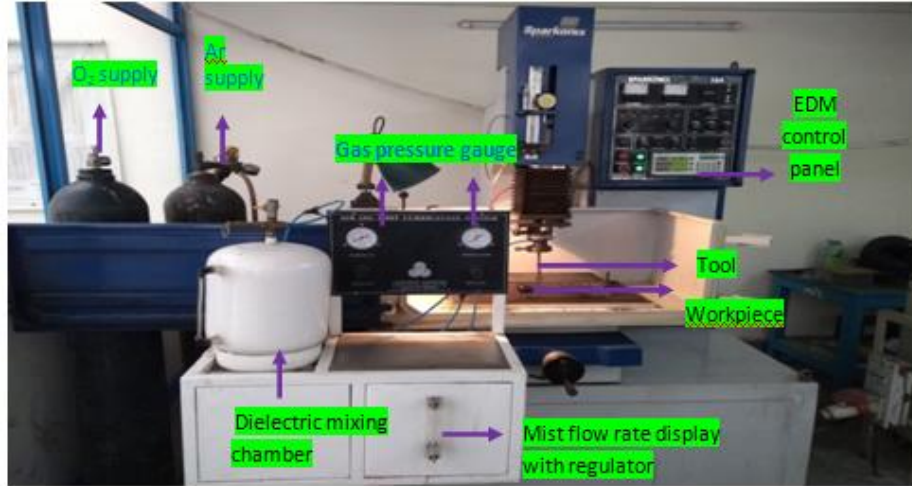

Fig. 1 Experimental setup for gaseous assisted powder mixed near dry EDM (GAPMND-EDM)

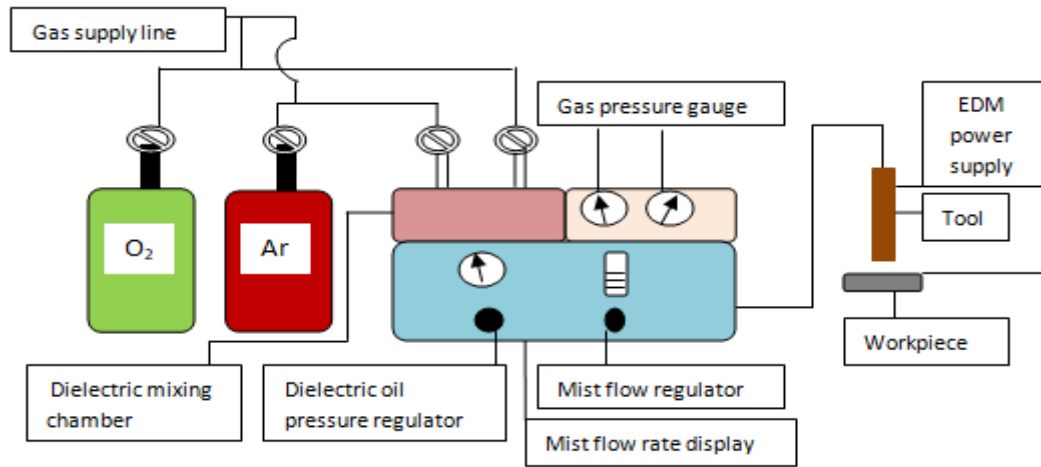

Fig. 2 Schematic diagram for gaseous assisted powder mixed near dry EDM (GAPMND-EDM)

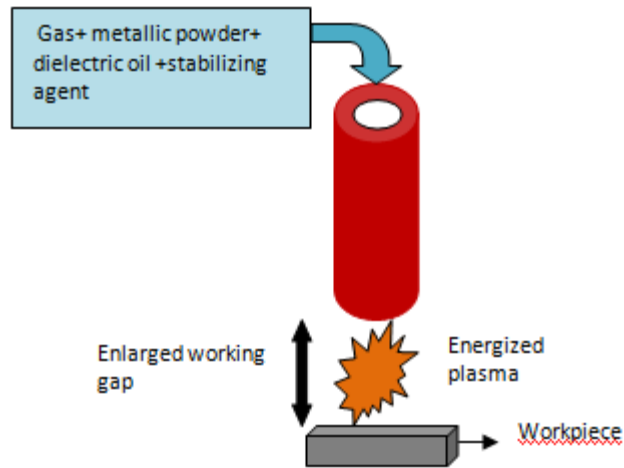

Fig.3 Working mechanism of GAPMND-EDM

Table 1 Process parameters for experimentation for ND-EDM and PMND-EDM.

Process parameter	Unit	ND-EDM	PMND-EDM
Dielectric medium		Gas + Dielectric oil	Gas + Dielectric oil + Metallic powder
Machining time	Mins	15	15
Discharge current	A	12	12
Pulse on	$\mu$ s	100	100
Gap voltage	V	45	45
Working pressure	MPa	0.8	0.8
Metallic powder concentration	g/l	-	15, 25, 35, 45
Type of metallic powder		-	Al, Gr, Si
Dielectric oil flow rate	ml/min	15	15
Gas		Argon	Argon
Workpiece electrode – EN-31, Tool electrode – Copper			

Table 2. Physical properties of workpiece EN -31.

Properties	Values
Thermal conductivity (W/m*K)	44.5
Hardness(HRC)	63
Yield stress (MPa)	450
Tensile strength (MPa)	750
Density (kg/m <sup>3</sup> )	7850
Melting point (°C)	1540

Table 3. Chemical composition of workpiece EN-31

Elements	C	Si	Mn	S	P	Cr
%	0.90-1.20	0.10-0.35	0.30-0.75	0.050	0.050	1-1.60

Table 4. Properties of metallic powders.

Property (Units)	Graphite	Aluminium	Silicon
Electrical resistivity (μΩ-cm)	30	5	10000
Thermal conductivity (W/m-K)	25 - 470	238	163
Heat of fusion (kJ/mol)	117	10.79	50.21
Specific heat (J/kg-K)	710	910	710
Melting temperature (°C)	3550	660	1414
Density (g/cm <sup>3</sup> )	1.26	2.7	2.33
Mohs hardness (HV)	1.5	3	6.5

### Analysis of thermal residual stress

Residual stress was measured with help of pulstec μX-360 machined as shown in Fig. 4. The machine works on Braggs law as given in Eq. (1):

$$N\lambda=2d\sin\theta \quad (1)$$

Where 'n' = order of reflection,  
 $\lambda$  = wavelength of the incident X-ray,  
d = Interplanar spacing of the crystal ,  
 $\theta$  =diffraction angle.

The residual stress was measured with the help of Debye- Scherrer created due to variation of orientation of crystal structure of the workpiece. This variation in orientation of crystal structure results in formation of strains which gives a direct relationship between the stress and strains as show in Eqs. (2-5)

$$\varepsilon_{\alpha 1} = \frac{1}{2} \{ (\varepsilon_{\alpha} - \varepsilon_{\pi+\alpha}) + (\varepsilon_{-\alpha} - \varepsilon_{\pi-\alpha}) \} \quad (2)$$

$$\varepsilon_{\alpha 2} = \frac{1}{2} \{ (\varepsilon_{\alpha} - \varepsilon_{\pi+\alpha}) - (\varepsilon_{-\alpha} - \varepsilon_{\pi-\alpha}) \} \quad (3)$$

$$\sigma_x = - \frac{E}{1+\nu} \cdot \frac{1}{\sin 2\eta} \cdot \frac{1}{\sin 2\varphi_0} \cdot \frac{\partial \varepsilon_{\alpha 1}}{\partial \cos \alpha} \quad (4)$$

$$\tau_{xy} = \frac{E}{2(1+\nu)} \cdot \frac{1}{\sin 2\eta} \cdot \frac{1}{\sin \varphi_0} \cdot \frac{\partial \varepsilon_{\alpha 2}}{\partial \sin \alpha} \quad (5)$$

Where  $\alpha$  = Debye-Sherrer ring azimuth angle;  
 $\varepsilon_{\pi+\alpha}$  = Strain in  $(\pi+\alpha)$  direction;  
 $\varepsilon_{\alpha 1}$  = Vertical direction strain;  
 $\varepsilon_{\alpha 2}$  = Horizontal direction strain;  
 $\sigma_x$  = Residual stress;  
 $\tau_{xy}$  = Shear stress (Residual);  
 $\nu$  = Poisson's ratio, E is Young's modulus;  
 $\varphi_0$  = Diffraction normal angle;  
 $\eta$  = Angle between Debye –Sherrer ring axis and the sample diffraction detector X-ray.



Fig. 4 Residual stress measuring machine

The least residual stress was found to be with Edm'ed samples by using silicon powder followed by aluminium and graphite as shown in Fig. 5. Lowest thermal conductivity of silicon powder was the main reason to produce the least amount of residual stress in the machined samples. While Figs. (6-8) shows the debye rings formation for machined samples under different experimentation conditions.



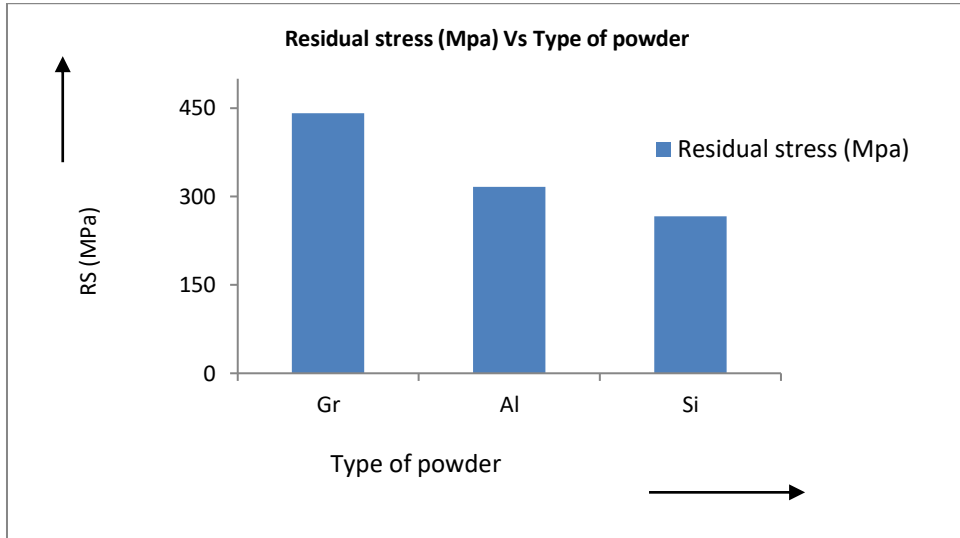

Fig. 5 Graph of residual stress Vs type of metallic powder.

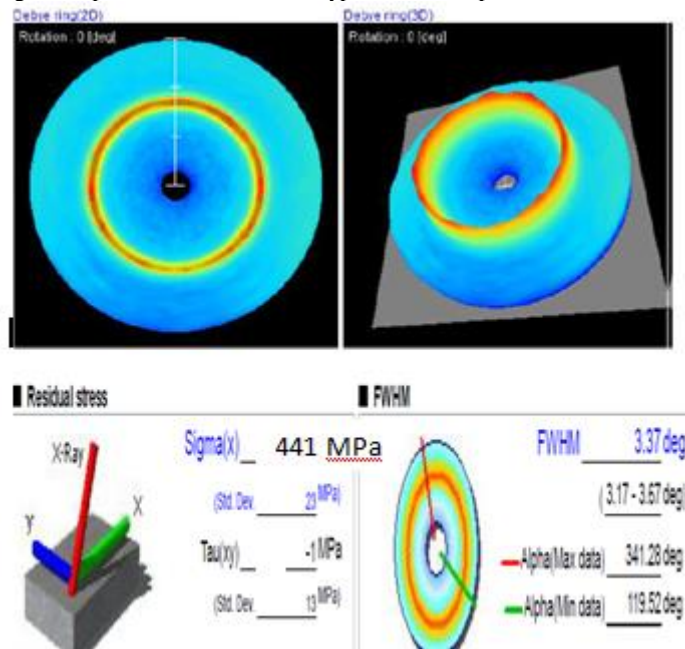

Fig.6 Residual stress debye rings for machined sample by graphite powder

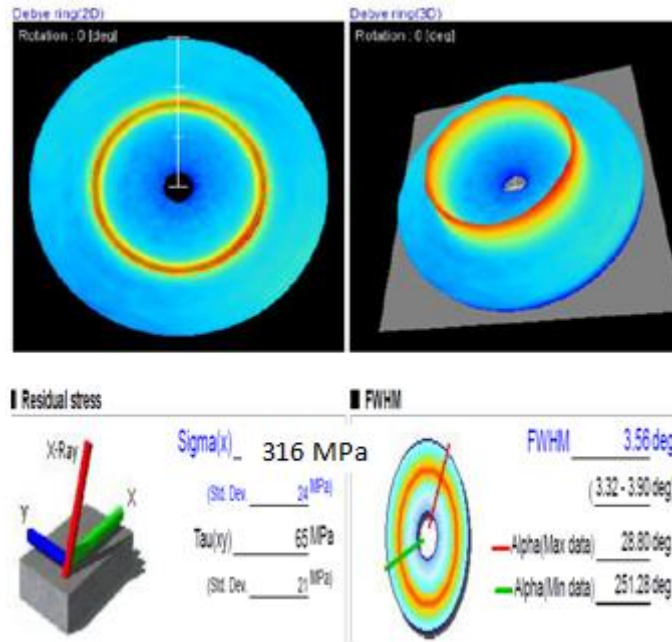

Fig.7 Residual stress debye rings for machined sample by aluminium powder

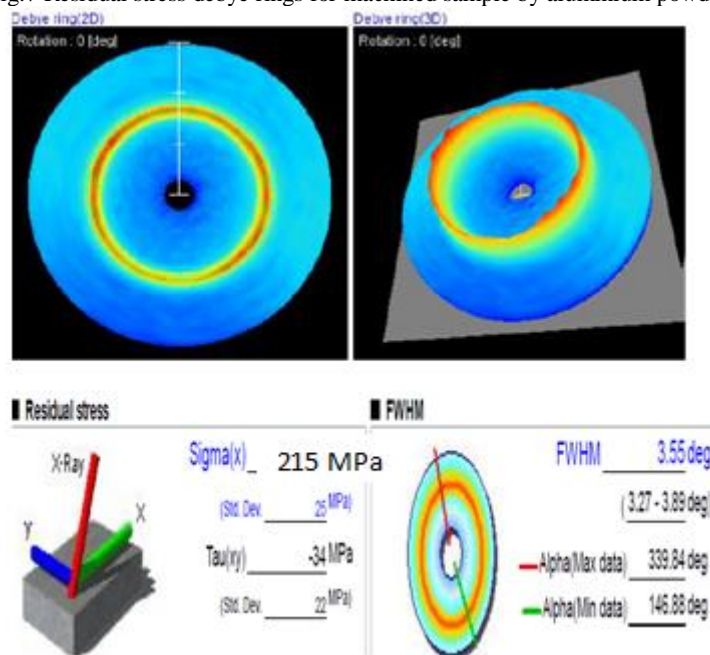

Fig.8 Residual stress debye rings for machined sample by silicon powder

### **Analysis of micro hardness**

Microhardness of the machined samples was measured with the help of Fischer-scope instrument (HM2000S model, USA) as shown in Fig. 9.



Fig.9 Microhardness measuring machine (Fischerscope instrument).

Surface hardening was achieved with the usage of metallic powder along with EDM oil because more pyrolysis effect was observed in the energized plasma channel between the tool and workpiece electrode which led to C-H bond breakage phenomenon. Hard carbides were formed over the machined surface by availability of more free carbon atoms. Another reason that can be attributed to increased microhardness was promotion of cuboidal  $\gamma'$  phase after thermal energy transfer to the workpiece. These increased microhardness value differed with different combination of dielectric additives (metallic powder). Among three different powders, Si powder proved to be better as compared to other powders in achieving the highest microhardness owing to its lowest thermal conductivity followed by aluminium and graphite powder as shown in Fig.10.

While higher electrical conductivity and aluminum carbide ( $Al_4C_3$ ) formation over the machined samples resulted in achieving higher microhardness in case of aluminium as compared to graphite powder

Microhardness improved with powder concentration as more particles enter the inter electrode gap as shown in Fig. 11.

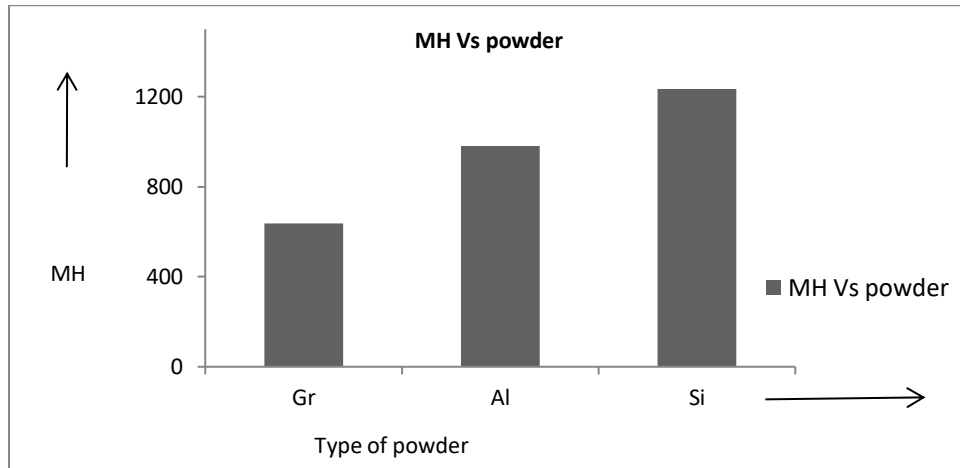

Fig.10 Microhardness Vs type of metallic powders.

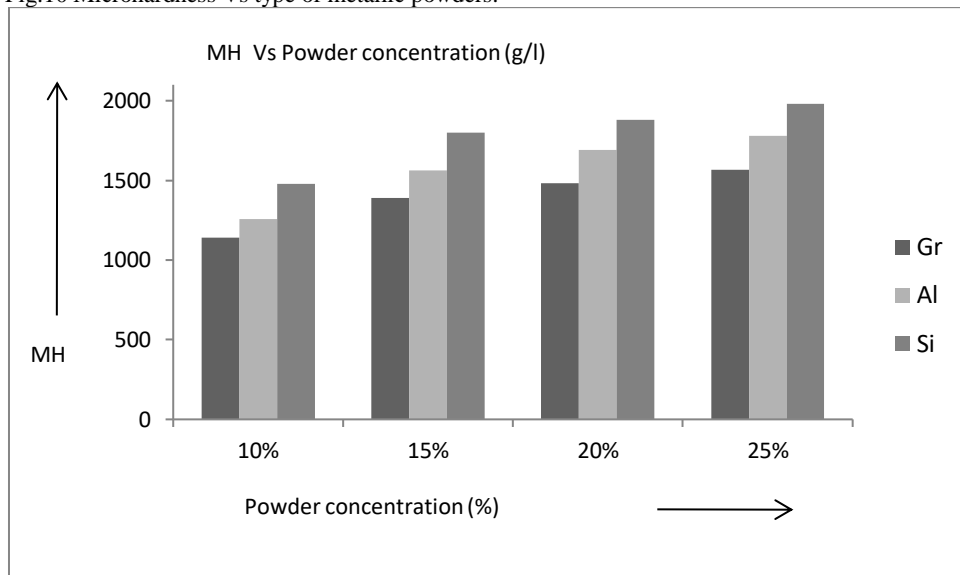

Fig.11 Microhardness Vs type of metallic powders with different concentration.

Hardness depth profile of the machined samples was measure along the direction of machining. It was seen that the highest value of microhardness was at the top surface of the machined samples as shown in Fig.12. Due to formation of recast layer by carbide formation and precipitation of  $\gamma'$  phase on the top surface. After a certain depth, the microhardness value depreciated due to diminished effect of heating and quenching.

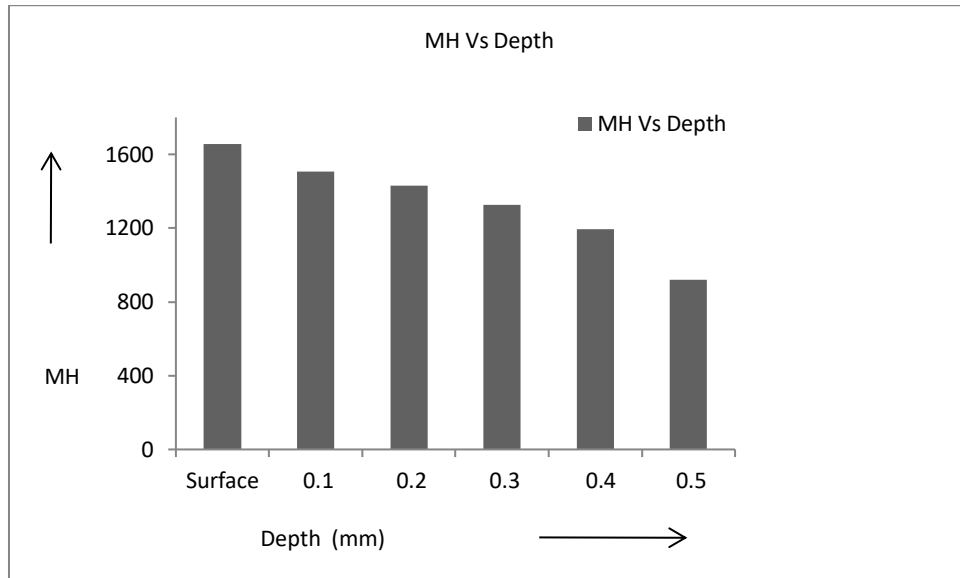

Fig.12 variation of Microhardness Vs Surface depth of the machined surface.

### Conclusion

- It was observed that the machining characteristics have been improved by GAPMND-EDM.
- The RS decreased by 39.68% while the microhardness increased by 93.57% in GAPMND-EDM by using silicon powder as a dielectric additive.
- Si powder was better in terms of increasing microhardness and decreasing residual stress of the machined samples as compared to Al and Gr powder.
- It was also observed that increase in metallic powder concentration led to increase in microhardness value generated over the machined surface.
- The maximum effect of increased microhardness was seen at the top most layer of the machined samples.

### References

1. Rao, P.S., Ramji, K. and Satyanarayana, B., "Effect of wire EDM conditions on generation of residual stresses in machining of aluminum 2014 T6 alloy," *Alex. Engg. J.*, Vol.55, pp. 1077–1084, 2016.
2. Shabgard, M., Seydi, S. and Seyedzavvar, M., "Novel approach towards finite element analysis of residual stresses in electrical discharge machining process," *Int. J. Adv. Manuf. Technol*, Vol. 82, pp. 1805–1814, 2016.

3. Kumar, S., Grover, S. and Walia, R.S., “Effect of hybrid wire EDM conditions on generation of residual stresses in machining of HCHCr D2 tool steel under ultrasonic vibration,” *Int. J. Interact. Des. Manuf.*, pp. 1-19, 2018.
4. Kumar, S. and Batra, U., “Surface modification of die steel materials by EDM method using tungsten powder-mixed dielectric,” *J. Manuf. Process.*, Vol. 14, pp. 35–40, 2012
5. Kumar, S., Singh, R., Batish, A., Singh, T. P. and Singh, R., “Investigating surface properties of cryogenically treated titanium alloys in powder mixed electric discharge machining,” *J. Braz. Soc. Mech Sci. Engg.*, Vol. 39, pp. 2635–2648, 2017.
6. Ogata, Y.M.: Residual stress on surface machined by wire electric discharge. *Int. J. Jap. Soc. Prec. Eng.* **25**, 273–278 (1991).
7. Kruth, J.P.; Bleys, P.: Measuring residual stresses caused by wire EDM of tool steel. *Int. J. Elect. mach.* **5**, 23–28 (2000).
8. Yadav, V.; Jain, V.K.; Dixit, P.M.: Thermal stresses due to electrical discharge machining. *Int. J. Mach. Tool. Manu.* **42**, 877–888 (2002).
9. Murali, M.S.; Yeo, S.H.: Process Simulation and Residual Stress Estimation of Micro-Electro discharge Machining Using Finite Element Method. *Jap. J. App. Phy.* **44**, 5254-5263 (2005).
10. Ekmekci, B.; Elkoca, O.; Tekkaya, A.E.; Erden, A.D.: Residual Stress State and Hardness Depth in Electric Discharge Machining: De-Ionized Water as Dielectric Liquid. *Mach. Sci. Technol.* **9**, 39-61 (2007).
11. Ekmekci, B.; Tekkaya, A.E.; Erden, A.D.: A semi-empirical approach for residual stresses in electric discharge machining (EDM). *Int. J. Mach. Tool. Manu.* **46**, 858–868 (2006).
12. Yang, X.; Han, X.; Zhou, F.; Kunieda, M.: Molecular dynamics simulation of residual stress generated in EDM. *Procedia. CIRP.* **6**, 433 – 438 (2013).
13. Liu, J.F.; Guo, Y.B.: Residual Stress Modeling in Electric Discharge Machining (EDM) by Incorporating Massive Random Discharges. *Procedia. CIRP.* **45**, 299 – 302 (2016).
14. Zain, Z.M.; Ndaliman, M.B.; Khan, A.A.; Ali, M.Y.: Improving micro-hardness of stainless steel through powder-mixed electrical discharge machining. *J. Mech. Eng. Sci.* **228**, 3374–3380 (2014).
15. Gill, A.S.; Kumar, S.: Surface Roughness and Micro hardness Evaluation for EDM with Cu-Mn Powder Metallurgy Tool. *Mater. Manuf. Process.* **31**, 514-521 (2016).
16. Gill, A.S.; Kumar, S.: Investigation of Micro-Hardness in Electrical Discharge Alloying of En31 Tool Steel with Cu–W Powder Metallurgy Electrode. *Arab. J. Sci. Eng.* <https://doi.org/10.1007/s13369-017-2960-x>
17. Chundru, V.R.; Koona, R.; Pujari, S.R.: Surface Modification of Ti6Al4V Alloy Using EDMed Electrode Made with Nano- and Micron-Sized Ti/Cu Powder Particles. *Arab. J. Sci. Eng.* <https://doi.org/10.1007/s13369-018-3561-z>

18. Rahul,; Datta, S.; Biswal, B.B.; Mahapatra, S.S.: A Novel Satisfaction Function and Distance-Based Approach for Machining Performance Optimization During Electro-Discharge Machining on Super Alloy Inconel 718. *Arab. J. Sci. Eng.* DOI 10.1007/s13369-017-2422-5
19. Talla G, Gangopadhyay S and Biswas CK, Influence of graphite powder mixed EDM on the surface integrity characteristics of Inconel 625 *Part. Sci. Technol.* 35 (2017) 219-226.
20. Kumar M, Datta S, Kumar R, Electro-discharge Machining Performance of Ti-6Al-4V Alloy: Studies on Parametric Effect and Phenomenon of Electrode Wear *Arab. J. Sci. Eng.* 44 (2018) 1-16
21. Khullar VR, Sharma N, Kishore S and Sharma R, RSM- and NSGA-II-Based Multiple Performance Characteristics Optimization of EDM Parameters for AISI 5160 *Arab. J. Sci. Eng.* 42 (2017) 1917-1928.
22. Singh J, Satsangi PS, Walia RS and Singh VP, Micro-hardness and machined surface damage study for continuous and discontinuous ultrasonic vibration assisted electrical discharge machining *Mat. Manuf. Process.* DOI: 10.1080/10426914.2011.585502
23. Singh J, Walia RS, Satsangi P and Singh V, FEM modeling of ultrasonic vibration assisted work-piece in EDM process *Int. J. Mech. Sys.Eng.* 1 (2011) 8-16
24. Kumar S, Grover S and Walia RS, Analyzing and modeling the performance index of ultrasonic vibration assisted EDM using graph theory and matrix approach *Int. J. Interact. Des. Manuf.* 12 (2016) DOI: 10.1007/s12008-016-0355-y
25. Zhao, W.S., Meng Q.G., Wang, Z.L.: The application of research on powder mixed EDM in rough machining. *J. Mater. Process. Technol.* 129, 30–33 (2002)
26. Gao, Q., Zhang, Q.H., Zhang, J.H.: Experimental study of powder-mixed near dry electrical discharge machining *Chin. J. Mech. Eng.* 45(1), 169–175 (2009)
27. Li, L., Zhao, L., Li, Z.Y., Feng, L., Bai, X.: Surface characteristics of Ti-6Al-4V by SiC abrasive-mixed EDM with magnetic stirring. *Mater. Manuf. Process.* 32(1), 83-86 (2016).
28. Amorim, F.L., Dalcin, V.A., Soares, P., Mendes, L. A.: Surface modification of tool steel by electrical discharge machining with molybdenum powder mixed in dielectric fluid. *Int. J. Adv. Manuf. Technol.* 91(1-4), 341–350 (2017).
29. Tripathy, S., Tripathy, D.K.: An approach for increasing the micro-hardness in electrical discharge machining by adding conductive powder to the dielectric. *Materials Today: Proceedings* 4, 1215–1224 (2017)
30. Sahu, S.K., Jadam, T., Datta, S., Dhupal, D., Nandi, G.: Application of SiC Power Added in Kerosene Dielectric Media for Electro-Discharge Machining of Inconel 718 Super Alloys: Effect of Powder Concentration. *Materials Today: Proceedings* 5, 20297–20305 (2018).

31. Opoz, T.T., Yasar, H., Ekmekci, N., Ekmekci, B.: Particle migration and surface modification on Ti6Al4V in SiC powder mixed electrical discharge machining. *J. Manuf. Process.* 31, 744–758 (2018).